

This installation guide serves as a complement to the product manual (Art.No. 1001001-2), included on the Nauticast Data Card (USB-Stick). **Installation of the Nauticast A2 AIS System should always be planned and executed by authorized personnel.** Please visit our web-site for the latest information regarding the Nauticast A2. www.nauticast.com

RECOMMENDED PHYSICAL INSTALLATION

Transponder unit should be mounted in a protected area and compass safe distances kept in mind (see table on the right). VHF antenna must be mounted vertically, free of reflective objects, minimum distance to other VHF antennas 1.5m and out of the radar beam. GPS antenna must have an omnidirectional view of the sky for ideal reception.

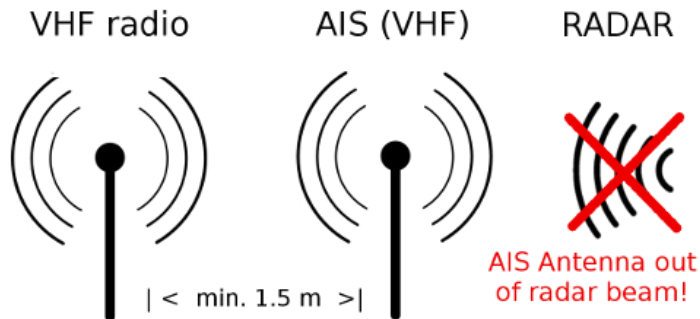

SYSTEM MODE

Important: The Nauticast A2 can operate in two different system modes, **Class A mode** (default) and **Inland mode**.

Inland mode is applicable to European river going vessels. Set mode in:

Main Menu → Config → System Settings → System Mode

Instructions only relevant for Inland AIS operation will be in brown print.

Physical

Nauticast A2
Size W x H x D: 238x87x173 (mm)
Gimbal Mount
Size W x H x D: 252x95x65 (mm)

Power

Input 12/24 VDC
Power Consumption: 20W (60W peak)
Required power on current: 4A

GPS Receiver (AIS internal)

Receiver: 50 CH
Frequency: L1 (1575.42 MHz)
Update Rate: 2 Hz
Position accuracy (SA off)
Position <2.0 m DGPS (CEP, 50%)
Position <2.5 m GPS (CEP, 50%)
Antenna feeding: 5 VDC

Electrical Interfaces

RS 422 Port	Default speed (bps)
Pilot In/Out	38400
ECDIS In/Out	38400
LR In/Out	9600
Sensor 1 In	4800
Sensor 2 In	4800
Sensor 3 In	4800

RS 232 Port	Default speed (bps)
RS232 In/Out	38400

Signal connector: 26 pin HD-SUB (M)
RS-232 connector: 9 pin D-SUB (M)
Power connector: 4 pin ConXall (M)
GPS 50 ohm antenna connector TNC female
VHF 50 ohm antenna connector BNC female

Chassis GND screw size: M6

Cables (recommended)

VHF and GPS RG214/U
Sensors e.g. Gyro RFE-HFI 2x2x0.75 mm²

Blue Sign Installation

Install Resistor connecting brown and orange wires:
12V: 2.2kΩ
24V: 10 kΩ

VHF Transceiver

Frequency 156-163 MHz
Output power 1/12.5 W
Channel bandwidth 25 kHz
Bit Rate 9600 bps
Intervals between position reports 1-180 s
Modulation FM-GMSK/GFSK
Transmitter 1
Receivers 3
Transceiver Sensitivity <-107 dBm

Environmental data

Protected environment (IEC 60945)
Operating temperature -15 °C to 55 °C

Compass safe distance

60 cm to standard magnetic compass
45 cm to steering magnetic compass

The Nauticast A2 AIS System is compliant with the following Standards

IMO Performance Standard for AIS (MSC 74(69) Annex 3)
ITU-R M. 1371-5
ITU-R M. 825-3
ITU-R M. 1084-5
IEC 61993-2 Edition 2
IEC 61162-1/2 Edition 4 (NMEA 0183, Version 4.0)
IEC 61108-1 Edition 2
IEC 60945 Edition 4
IEC 62288 Edition 2
IALA Guidelines on AIS
Inland Test Standard Ed. 2.0

Specifications subject to change without notice

SYSTEM CONFIGURATION

NOTE: Set correct System mode (CLASS A / Inland before proceeding)

Set up the following parameters under: *Main Menu → Config → Ship Static*

Class A Mode	Inland Mode
MMSI	MMSI
IMO	IMO = 0
Call Sign	Call Sign
Ship Name	Ship Name
Height over Keel	Height over Keel
Ship Type	ERI Code / Euro type
Ship Dimension*	SOG/COG/HDG quality
-	Euro number
	Ship and Convoy total Dimensions*

*SET SHIP DIMENSIONS

There are two methods for setting Ship Dimensions: configuration parameter "**Ship Size Mode**" in the view "**Config-> Interfaces -> Miscellaneous**" can be set to **Standard Mode** or **Simplified Mode** (default). This choice is only available in Class A system mode!

If external ECDIS will be used for full AIS configuration, Standard Mode is recommended unless the ECDIS integration has been verified with A2.

Standard Mode (not available in Inland mode)

In this mode data is entered exactly as is will be reported on VHF link.

Input:

- A, B, C, D for internal antenna [m]
- A, B, C, D for external antenna [m]

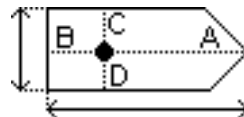

Simplified Mode (default)

In **Simplified mode** the transponder will automatically calculate and correctly round the A,B,C and D values reported on the VHF link from Length, Beam, C and B.

Input:

- *Ship length x.x* [m] (one decimal precision)
- *Ship beam x.x* [m] (one decimal precision)
- C, B for internal antenna relative to ship x.x [m] (one decimal precision)
- C, B for external antenna relative to ship x.x [m] (one decimal precision)

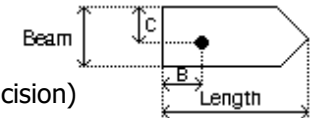

Inland Mode Convoy Setting (Inland only):

Set Length, Beam, C and B parameters as above.

Specify any extra convoy size in *Main Menu→Voyage→Convoy Settings*.

Extra convoy size on each side (value = 0 if convoy not used):

- *Bow x.x* [m] (one decimal precision)
- *Stern x.x* [m] (one decimal precision)
- *Port side x.x* [m] (one decimal precision)
- *Starboard x.x* [m] (one decimal precision)

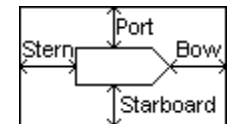

A,B,C and D values reported on the VHF link will be calculated from Length, Beam, C,B and any extra convoy sizes.

This mode will make it easier for Inland AIS users to quickly change all relevant dimensions when changing convoy configuration, but may cause problems for external ECDIS integrations.

SYSTEM FUNCTIONAL TEST

Please consult the product manual, included on the Nauticast Data Card (USB-Stick), if any problems are detected.

SYSTEM POWER UP

The Nauticast A2 will start to operate when power is connected, the device does not have a power switch. The system is fully operational within 2 minutes.

TRANSPONDER STATUS LEDs

Normal operation can be verified using the LEDs on the front. Tx and Rx LEDs will flash during VHF Tx and Rx. Status LEDs on the transponder signal these operational states:

SYSTEM STATUS	STATUS LED
Normal Operation	Solid GREEN
Unacknowledged active alarms	Flashing RED
Acknowledged active alarms	Solid RED
Power failure	OFF

Note: LEDs will behave differently during a system boot. Allow two minutes from power-on before checking of LED status.

ALARM LIST

Make sure no unexpected alarms are active. *Main Menu → Alarms*

Disable any active alarms not applicable for the installation in the Alarm Config View. *Main Menu → Config → Alarm*

TIME AND DATE

Verify system time and date in the upper right corner. If incorrect, the transponder internal GPS does not have a position fix. This will also be indicated by an alarm "UTC Sync Invalid".

GPS STATUS

Verify GPS antenna installation quality in the GPS Status View

Main Menu → Status → GPS Status

VHF Communication Test

Verify two way VHF communication with other vessels in the Comm. Test View. *Menu → Maintenance → Comm. Test.*

Mounting

The Nauticast A2 can be panel or gimbal mounted (optional accessories 1001005 or 1001006). For flush mounting, remove the gimbal mount jacket. Use the cutout dimensions in the figure below. Do not exceed the cutout area, the screw holes may be too close to the cutout. A 1:1 scale cutout drawing is included on the Data Card. If printed, verify scale has not changed by measuring given dimensions.

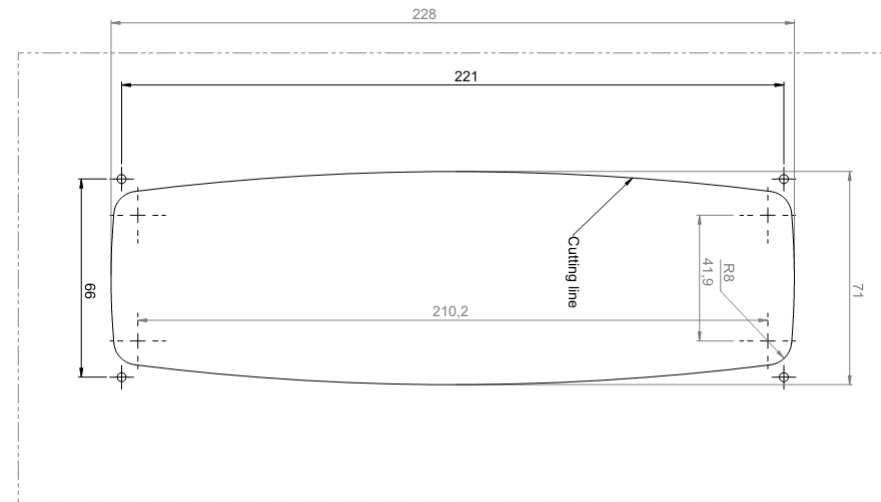

Blue Sign Installation

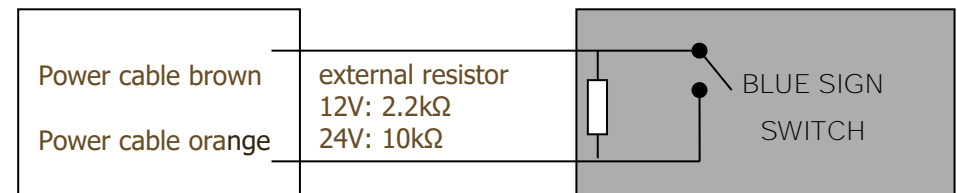

Nauticast A2 Signal Cable DSUB-OPEN, 1001003

26-pin High Density D-Sub, female. Out/Tx = Data from transponder.

Pin	In/Out	Signal Name	Signal Type	Colour
1	Out	ECDIS - TxB (+)	RS422	White
2	Out	ECDIS - TxA (-)	RS422	Brown
3	In	Sensor1 - RxB (+)	RS422	Green
4	In	Sensor1 - RxA (-)	RS422	Yellow
5	In	Sensor2 - RxB (+)	RS422	Grey
6	In	Sensor2 - RxA (-)	RS422	Pink
7	In	Long Range - RxB (+)	RS422	Blue
8	In	Long Range - RxA (-)	RS422	Red
9	-	Long Range - GND	RS422	Black
10	-	ECDIS - GND	RS422	Violet
11	In	ECDIS - RxB (+)	RS422	Grey / Pink
12	In	ECDIS - RxA (-)	RS422	Red / Blue
13	-	Sensor1 - GND	RS422	White / Green
14	-	Sensor2 - GND	RS422	Brown / Green
15	In	Sensor3 - RxB (+)	RS422	White / Yellow
16	In	Sensor3 - RxA (-)	RS422	Yellow /
17	Out	Long Range - TxB (+)	RS422	White / Grey
18	Out	Long Range - TxA (-)	RS422	Grey / Brown
19	-	Alarm Relay - GND	-	White / Pink
20	Out	Alarm Relay - Out	-	Pink / Brown
21	-	GND	-	White / Blue
22	-	TX test pin (do not connect!)	-	-
23	-	Sensor3 - GND	RS422	White / Red
24	-	Alarm Relay - VCC	-	Brown / Red
25	In/Out	CAN (+)	Diff. CAN bus	White/Black
26	In/Out	CAN (-)	Diff. CAN bus	Brown/Black

A2 Power Cable, 1001001-1

4-pin male circular ConXall, female.
5A Fuse.

Pin	Signal Name	Colour
1	12/24VDC positive	Red
2	GND	Black
3*	External Switch	Brown
4*	External Switch	Orange

***See manual on documentation CD/USB-Stick for details on external switch installation.**

Transponder 232 pinout

Tx = from transponder.
Default 38400 bps.

Pin	Signal Name
1	Not Connected
2	AIS Data Tx
3	AIS Data Rx
4	Not Connected
5	GND
6	Not Connected
7	Not Connected
8	Not Connected
9	Not Connected

Use a standard DE9F to DE9M Serial Cable.

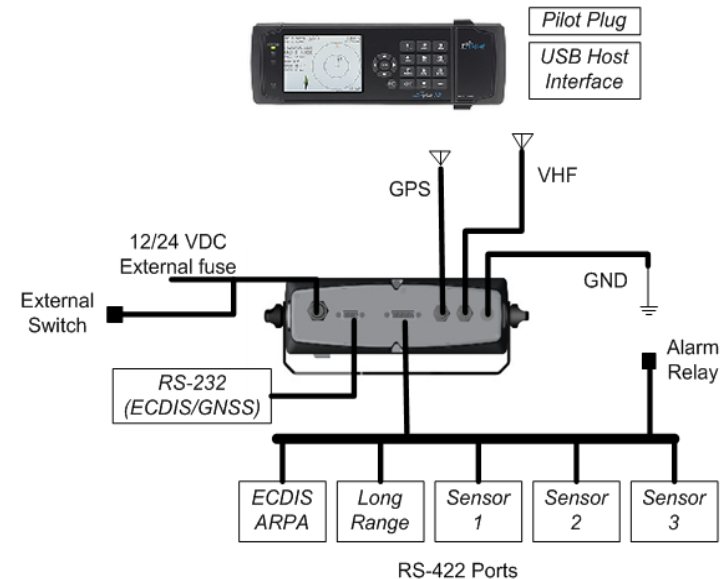

System overview